



**PROPRIETARY NOTE**  
THIS SPECIFICATION IS THE PROPERTY OF BOE HF AND SHALL NOT BE REPRODUCED OR COPIED WITHOUT THE WRITTEN PERMISSION OF BOE HF AND MUST BE RETURNED TO BOE HF UPON ITS REQUEST

SPEC. NUMBER	PRODUCT GROUP	Rev.	ISSUE DATE	PAGE
	TFT-LCD	P0	2011.11.23	1 OF 36

**HB156WX1-100**  
**Preliminary Product Specification P0**

HEFEI BOE OPTOELECTRONICS TECHNOLOGY



 <b>京东方</b> <b>BOE</b>	<b>PRODUCT GROUP</b>	REV	ISSUE DATE
	TFT- LCD PRODUCT	P0	2011.11.23
SPEC. NUMBER	SPEC. TITLE HB156WX1-100 Preliminary Product Specification		PAGE 3 OF 36

## Contents

No.	Item	Page
1.0	General Description	4
2.0	Absolute Maximum Ratings	6
3.0	Electrical Specifications	7
4.0	Optical Specifications	10
5.0	Interface Connection	15
6.0	Signal Timing Specification	19
7.0	Signal Timing waveforms	21
8.0	Input Signals, Display Colors & Gray Scale of Colors	23
9.0	Power Sequence	24
10.0	Connector description	25
11.0	Mechanical Characteristics	26
12.0	Reliability Test	27
13.0	Handling & Cautions.	27
14.0	Label	28
15.0	Packing information	30
16.0	Mechanical Outline Dimension	31
17.0	EDID Table	33

 <b>京东方</b> <b>BOE</b>	<b>PRODUCT GROUP</b>	REV	ISSUE DATE
	TFT- LCD PRODUCT	P0	2011.11.23
SPEC. NUMBER	SPEC. TITLE HB156WX1-100 Preliminary Product Specification		PAGE 4 OF 36

## 1.0 GENERAL DESCRIPTION

### 1.1 Introduction

HB156WX1-100 is a color active matrix TFT LCD module using amorphous silicon TFT's (Thin Film Transistors) as an active switching devices. This module has a 15.6 inch diagonally measured active area with HD resolutions (1366 horizontal by 768 vertical pixel array). Each pixel is divided into RED, GREEN, BLUE dots which are arranged in vertical Stripe and this module can display 262,144 colors. The TFT-LCD panel used for this module is a low reflection and higher color type. Therefore, this module is suitable for Notebook PC. The LED Driver for back-light driving is built in this model. All input signals are LVDS interface compatible.

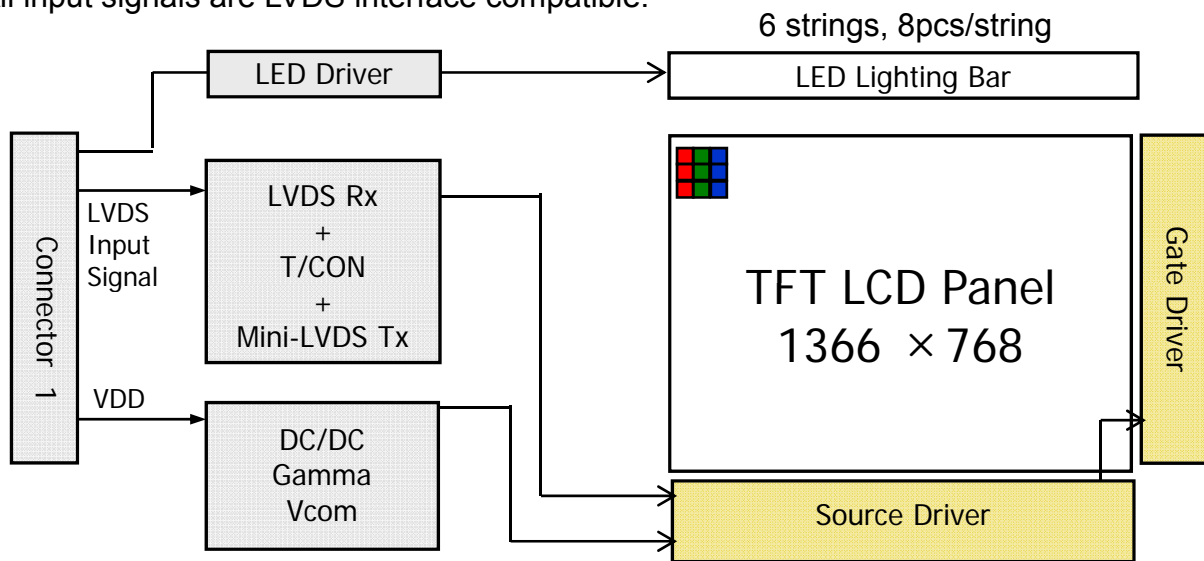

### 1.2 Features

- 1 Channel LVDS Interface with 1 pixel / clock
- Thin and light weight
- 6-bit color depth, display 262K colors
- Single LED Lighting Bar. (Up side/Horizontal Direction)
- Data enable signal mode
- Side Mounting Frame
- Green Product (RoHS & Halogen free product)
- On board LED Driving circuit
- Low driving voltage and low power consumption
- On board EDID chip

 <b>京东方 BOE</b>	<b>PRODUCT GROUP</b>	REV	ISSUE DATE
	TFT- LCD PRODUCT	P0	2011.11.23
SPEC. NUMBER	SPEC. TITLE HB156WX1-100 Preliminary Product Specification	PAGE 5 OF 36	

### 1.3 Application

- Notebook PC (Wide type)

### 1.4 General Specification

The followings are general specifications at the model HB156WX1-100. (listed in Table 1.)

<Table 1. General Specifications>

Parameter	Specification	Unit	Remarks
Active area	344.232(H) × 193.536(V)	mm	
Number of pixels	1366 (H) × 768 (V)	pixels	
Pixel pitch	0.252 (H) × 0.252 (V)	mm	
Pixel arrangement	RGB Vertical stripe		
Display colors	262K	colors	
Display mode	Normally White		
Dimensional outline	359.3±0.5 (H) × 209.5±0.5 (V) × 5.5 (D:max)	mm	
Weight	450 (max)	g	
Surface treatment	Glare / Hardness 3H		
Back-light	Up edge side, 1-LED Lighting Bar type		
Power consumption	P <sub>D</sub> : 1.2 (max)	W	
	P <sub>BL</sub> : 3.7 (max)	W	
	P <sub>total</sub> : 4.9(max)	W	

 <b>京东方 BOE</b>	<b>PRODUCT GROUP</b>	REV	ISSUE DATE
	TFT- LCD PRODUCT	P0	2011.11.23
SPEC. NUMBER	SPEC. TITLE HB156WX1-100 Preliminary Product Specification		PAGE 6 OF 36

## 2.0 ABSOLUTE MAXIMUM RATINGS

The followings are maximum values which, if exceed, may cause faulty operation or damage to the unit. The operational and non-operational maximum voltage and current values are listed in Table 2.

< Table 2. Absolute Maximum Ratings >

Ta=25+/-2°C

Parameter	Symbol	Min.	Max.	Unit	Remarks
Power Supply Voltage	V <sub>DD</sub>	-0.3	4.0	V	Note 1
Logic Supply Voltage	V <sub>IN</sub>	V <sub>SS</sub> -0.3	V <sub>DD</sub> +0.3	V	
Operating Temperature	T <sub>OP</sub>	0	+50	°C	Note 2
Storage Temperature	T <sub>ST</sub>	-20	+60	°C	

- Notes : 1. Permanent damage to the device may occur if maximum values are exceeded functional operation should be restricted to the condition described under normal operating conditions.
2. Temperature and relative humidity range are shown in the figure below.  
 95 % RH Max. ( 40 °C ≥ Ta)  
 Maximum wet - bulb temperature at 39 °C or less. (Ta > 40 °C) No condensation.

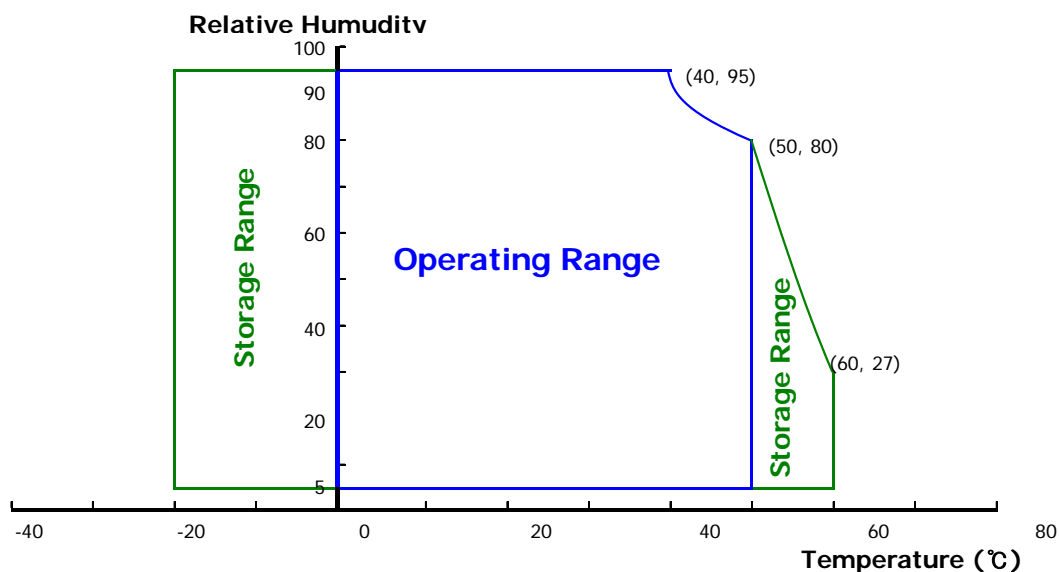

 <b>京东方</b> <b>BOE</b>	<b>PRODUCT GROUP</b>	REV	ISSUE DATE
	TFT- LCD PRODUCT	P0	2011.11.23
SPEC. NUMBER	SPEC. TITLE HB156WX1-100 Preliminary Product Specification		PAGE 7 OF 36

### 3.0 ELECTRICAL SPECIFICATIONS

#### 3.1 Electrical Specifications

< Table 3. Electrical specifications >

Ta=25+/-2°C

Parameter		Min.	Typ.	Max.	Unit	Remarks
Power Supply Voltage	V <sub>DD</sub>	3.0	3.3	3.6	V	Note 1
Permissible Input Ripple Voltage	V <sub>RF</sub>	-	-	100	mV	At V <sub>DD</sub> = 3.3V
In-rush Current	I <sub>RUSH</sub>	-	-	1.5	A	
Power Supply Current	I <sub>DD</sub>	-	290	360	mA	Note 1
Positive-going Input Threshold Voltage	V <sub>IT+</sub>	-	-	100	mV	V <sub>cm</sub> = 1.2V typ.
Negative-going Input Threshold Voltage	V <sub>IT-</sub>	-100	-	-	mV	
Differential Input Voltage	V <sub>ID</sub>	100	-	600	mV	
Power Consumption	P <sub>D</sub>	-	0.95	1.2	W	Note 1
	P <sub>BL</sub>	-	3.60	3.7	W	Note 2
	P <sub>total</sub>	-	4.55	4.9	W	

Notes : 1. The supply voltage is measured and specified at the interface connector of LCM.  
The current draw and power consumption specified is for 3.3V at 25°C.

a) Typ : Window XP pattern

b) Max : Vertical 2 line skip pattern

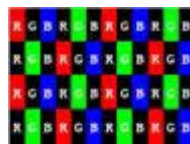

2. Calculated value for reference (P<sub>LED</sub> /LED driver efficiency(0.9))

 <b>京东方</b> <b>BOE</b>	<b>PRODUCT GROUP</b>	REV	ISSUE DATE
	TFT- LCD PRODUCT	P0	2011.11.23
SPEC. NUMBER	SPEC. TITLE HB156WX1-100 Preliminary Product Specification		PAGE 8 OF 36

### 3.0 ELECTRICAL SPECIFICATIONS

#### 3.2 Backlight Unit

< Table 4. LED Driving guideline specifications > Ta=25+/-2°C

Parameter		Min.	Typ.	Max.	Unit	Remarks
LED Forward Voltage	V <sub>F</sub>	3.0	3.2	3.4	V	-
LED Forward Current	I <sub>F</sub>	-	20		mA	-
LED Power Consumption	P <sub>LED</sub>		3.1	3.3	W	Note 1
LED Life-Time	N/A	15,000	-	-	Hour	I <sub>F</sub> = 20mA Note 2
Power supply voltage for LED Driver	V <sub>LED</sub>	6	12	21	V	
EN Control Level	Backlight on	2.0		5.0	V	
	Backlight off	0		1.0	V	
PWM Control Level	PWM High Level	2.0		5.0	V	
	PWM Low Level	0		0.1	V	
PWM Control Frequency	F <sub>PWM</sub>	100	1k	10k	Hz	
Duty Ratio	-	1	-	100	%	

Notes : 1. Calculator Value for reference  $I_F \times V_F \times 48 = P_{LED}$

2. The LED Life-time define as the estimated time to 50% degradation of initial luminance.

 <b>京东方 BOE</b>	<b>PRODUCT GROUP</b>	REV	ISSUE DATE
	TFT- LCD PRODUCT	P0	2011.11.23
SPEC. NUMBER	SPEC. TITLE HB156WX1-100 Preliminary Product Specification		PAGE 9 OF 36

### 3.3 LED structure

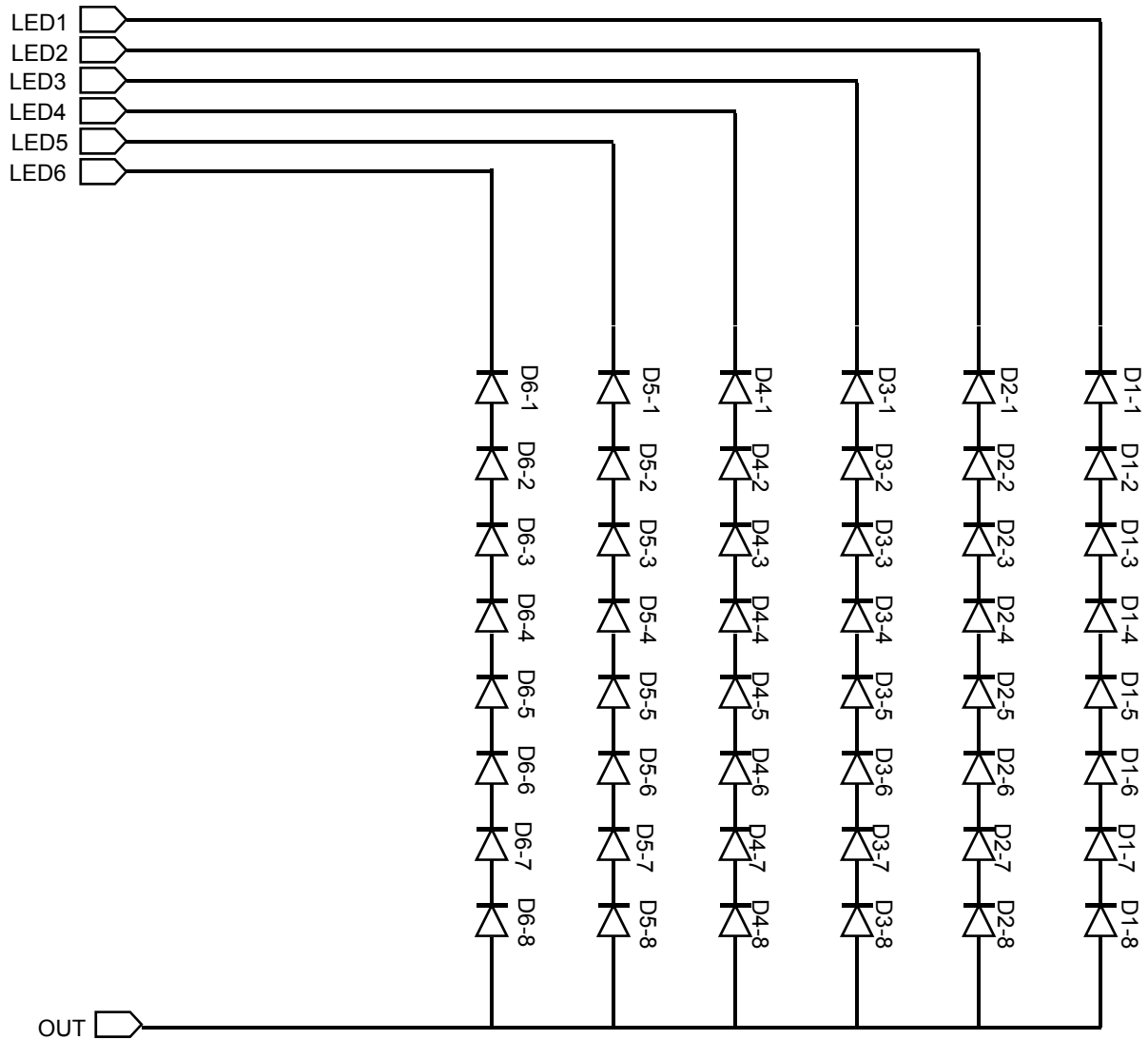

 <b>京东方 BOE</b>	<b>PRODUCT GROUP</b>	REV	ISSUE DATE
	TFT- LCD PRODUCT	P0	2011.11.23
SPEC. NUMBER	SPEC. TITLE HB156WX1-100 Preliminary Product Specification	PAGE 10 OF 36	

## 4.0 OPTICAL SPECIFICATION

### 4.1 Overview

The test of Optical specifications shall be measured in a dark room (ambient luminance  $\leq 1$  lux and temperature =  $25 \pm 2^\circ\text{C}$ ) with the equipment of Luminance meter system (Goniometer system and TOPCON BM-5) and test unit shall be located at an approximate distance 50cm from the LCD surface at a viewing angle of  $\theta$  and  $\Phi$  equal to  $0^\circ$ . We refer to  $\theta\Phi=0$  ( $=\theta_3$ ) as the 3 o'clock direction (the "right"),  $\theta\Phi=90$  ( $=\theta_{12}$ ) as the 12 o'clock direction ("upward"),  $\theta\Phi=180$  ( $=\theta_9$ ) as the 9 o'clock direction ("left") and  $\theta\Phi=270$  ( $=\theta_6$ ) as the 6 o'clock direction ("bottom"). While scanning  $\theta$  and/or  $\Phi$ , the center of the measuring spot on the Display surface shall stay fixed. The backlight should be operating for 30 minutes prior to measurement. VDD shall be  $3.3 \pm 0.3\text{V}$  at  $25^\circ\text{C}$ . Optimum viewing angle direction is 6 o'clock.

### 4.2 Optical Specifications

<Table 5. Optical Specifications>

Parameter		Symbol	Condition	Min.	Typ.	Max.	Unit	Remark
Viewing Angle range	Horizontal	$\Theta_3$	CR > 10	40	45	-	Deg.	Note 1
		$\Theta_9$		40	45	-	Deg.	
	Vertical	$\Theta_{12}$		10	15	-	Deg.	
		$\Theta_6$		30	35	-	Deg.	
Luminance Contrast ratio		CR	$\Theta = 0^\circ$	400	500			Note 2
Luminance of White	5 Points	$Y_w$	$\Theta = 0^\circ$ ILED = 20mA	187	220	-	cd/m <sup>2</sup>	Note 3
White Luminance uniformity	5 Points	$\Delta Y_5$		80	-	-		Note 4
	13 Points	$\Delta Y_{13}$		65	-	-		
White Chromaticity		$x_w$	$\Theta = 0^\circ$	0.283	0.313	0.343		Note 5
		$y_w$		0.299	0.329	0.359		
Reproduction of color	Red	$x_R$	$\Theta = 0^\circ$	-0.03	0.643	+0.03		
		$y_R$			0.355			
	Green	$x_G$			0.331			
		$y_G$			0.613			
	Blue	$x_B$			0.151			
		$y_B$			0.110			
Color Gamut			$\Theta = 0^\circ$	60		%		
Response Time (Rising + Falling)		$T_{RT}$	Ta = $25^\circ\text{C}$ $\Theta = 0^\circ$	-	8	16	ms	Note 6
Cross Talk		CT	$\Theta = 0^\circ$	-	-	2.0	%	Note 7

 京东方 BOE	PRODUCT GROUP	REV	ISSUE DATE
	TFT- LCD PRODUCT	P0	2011.11.23
SPEC. NUMBER	SPEC. TITLE HB156WX1-100 Preliminary Product Specification		PAGE 11 OF 36

Notes : 1. Viewing angle is the angle at which the contrast ratio is greater than 10. The viewing angles are determined for the horizontal or 3, 9 o'clock direction and the vertical or 6, 12 o'clock direction with respect to the optical axis which is normal to the LCD surface (see FIGURE 1).

2. Contrast measurements shall be made at viewing angle of  $\Theta = 0$  and at the center of the LCD surface. Luminance shall be measured with all pixels in the view field set first to white, then to the dark (black) state .  
(see FIGURE 1) Luminance Contrast Ratio (CR) is defined mathematically.

$$CR = \frac{\text{Luminance when displaying a white raster}}{\text{Luminance when displaying a black raster}}$$

3. Center Luminance of white is defined as luminance values of 5 point average across the LCD surface. Luminance shall be measured with all pixels in the view field set first to white. This measurement shall be taken at the locations shown in FIGURE 2 for a total of the measurements per display.
4. The White luminance uniformity on LCD surface is then expressed as :  $\Delta Y = \text{Minimum Luminance of 5(or 13) points} / \text{Maximum Luminance of 5(or 13) points}$  (see FIGURE 2 and FIGURE 3).
5. The color chromaticity coordinates specified in Table 5 shall be calculated from the spectral data measured with all pixels first in red, green, blue and white. Measurements shall be made at the center of the panel.
6. The electro-optical response time measurements shall be made as FIGURE 4 by switching the "data" input signal ON and OFF. The times needed for the luminance to change from 10% to 90% is  $T_r$ , and 90% to 10% is  $T_d$ .
7. Cross-Talk of one area of the LCD surface by another shall be measured by comparing the luminance (YA) of a 25mm diameter area, with all display pixels set to a gray level, to the luminance (YB) of that same area when any adjacent area is driven dark. (See FIGURE 5).

 京东方 BOE	PRODUCT GROUP	REV	ISSUE DATE
	TFT- LCD PRODUCT	P0	2011.11.23
SPEC. NUMBER	SPEC. TITLE HB156WX1-100 Preliminary Product Specification		PAGE 12 OF 36

### 4.3 Optical measurements

Figure 1. Measurement Set Up

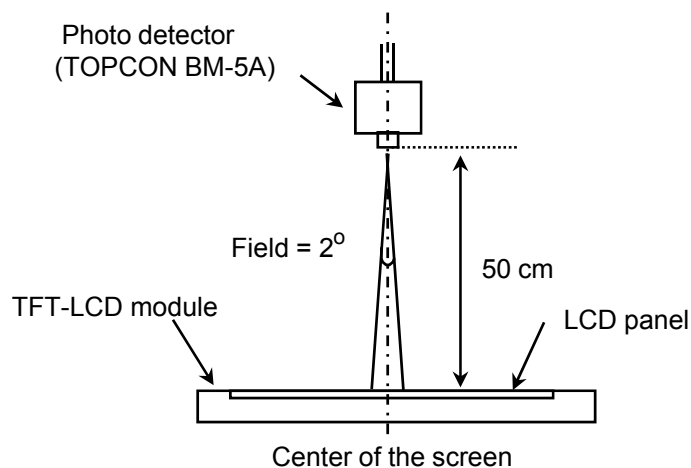

Optical characteristics measurement setup

Figure 2. White Luminance and Uniformity Measurement Locations (5 points)

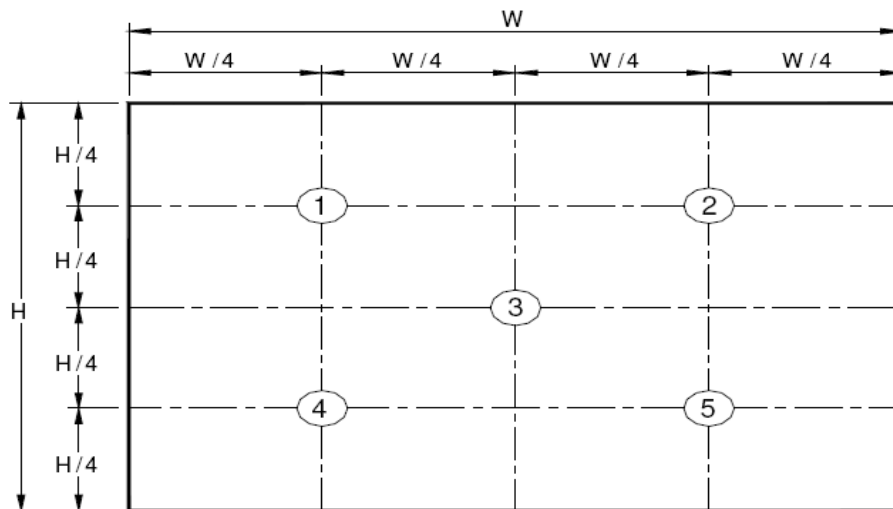

Center Luminance of white is defined as luminance values of center 5 points across the LCD surface. Luminance shall be measured with all pixels in the view field set first to white. This measurement shall be taken at the locations shown in FIGURE 2 for a total of the measurements per display.

 <b>京东方</b> <b>BOE</b>	<b>PRODUCT GROUP</b>	REV	ISSUE DATE
	TFT- LCD PRODUCT	P0	2011.11.23
SPEC. NUMBER	SPEC. TITLE HB156WX1-100 Preliminary Product Specification	PAGE 13 OF 36	

**Figure 3. Uniformity Measurement Locations (13 points)**

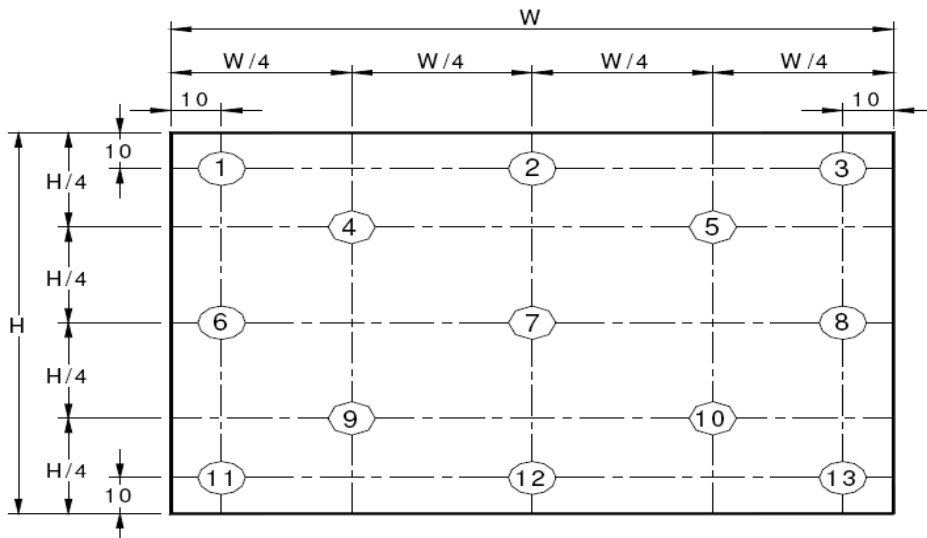

The White luminance uniformity on LCD surface is then expressed as :  $\Delta Y5 = \text{Minimum Luminance of five points} / \text{Maximum Luminance of five points}$  (see FIGURE 2) ,  $\Delta Y13 = \text{Minimum Luminance of 13 points} / \text{Maximum Luminance of 13 points}$  (see FIGURE 3).

**Figure 4. Response Time Testing**

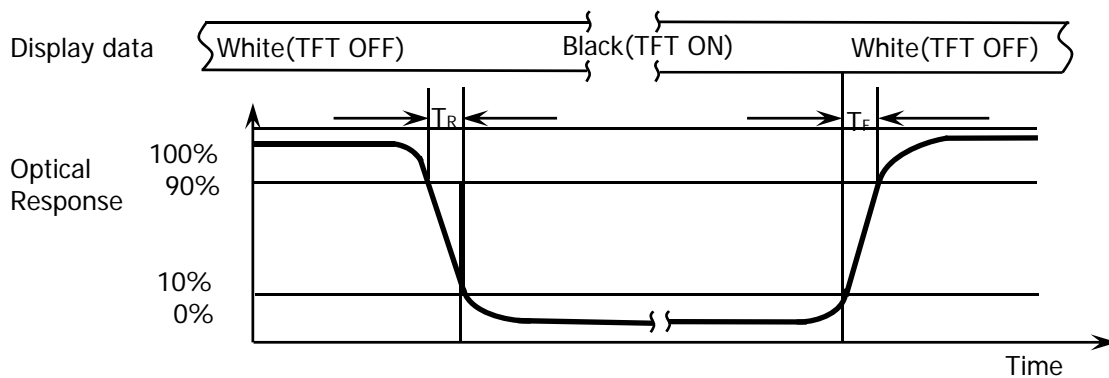

The electro-optical response time measurements shall be made as shown in FIGURE 4 by switching the “data” input signal ON and OFF. The times needed for the luminance to change from 10% to 90% is  $T_d$  and 90% to 10% is  $T_r$ .

 京东方 BOE	PRODUCT GROUP	REV	ISSUE DATE
	TFT- LCD PRODUCT	P0	2011.11.23
SPEC. NUMBER	SPEC. TITLE HB156WX1-100 Preliminary Product Specification		PAGE 14 OF 36

**Figure 5. Cross Modulation Test Description**

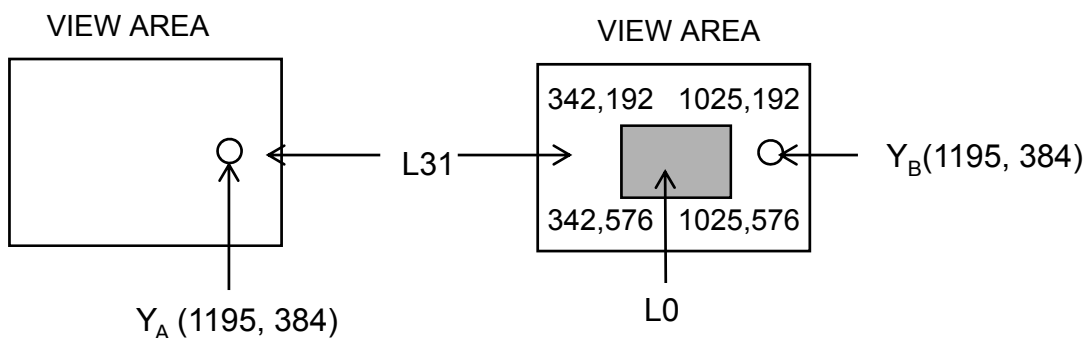

$$\text{Cross-Talk (\%)} = \left| \frac{Y_B - Y_A}{Y_A} \right| \times 100$$

Where:

$Y_A$  = Initial luminance of measured area (cd/m<sup>2</sup>)

$Y_B$  = Subsequent luminance of measured area (cd/m<sup>2</sup>)

The location measured will be exactly the same in both patterns

Cross-Talk of one area of the LCD surface by another shall be measured by comparing the luminance ( $Y_A$ ) of a 25mm diameter area, with all display pixels set to a gray level, to the luminance ( $Y_B$ ) of that same area when any adjacent area is driven dark (Refer to FIGURE 5).

 <b>京东方 BOE</b>	<b>PRODUCT GROUP</b>	REV	ISSUE DATE
	TFT- LCD PRODUCT	P0	2011.11.23
SPEC. NUMBER	SPEC. TITLE HB156WX1-100 Preliminary Product Specification	PAGE 15 OF 36	

## 5.0 INTERFACE CONNECTION.

### 5.1 Electrical Interface Connection

The electronics interface connector is STM MSAK24025P40G. The connector interface pin assignments are listed in Table 6.

<Table 6. Pin Assignments for the Interface Connector>

Terminal	Symbol	Functions
Pin No.	Symbol	Description
1	NC	No Connection
2	VDDIN	Power Supply, 3.3V (typ.)
3	VDDIN	Power Supply, 3.3V (typ.)
4	VDC	VDC 3.3V power for EDID
5	BISTC	BIST control(Note.1)
6	CLK EDID	EDID Clock
7	Data EDID	EDID Data
8	RxIN0-	Transmission Data of 0 Negative -
9	RxIN0+	Transmission Data of 0 Positive +
10	GND	Ground
11	RxIN1-	Transmission Data of 1 Negative -
12	RxIN1+	Transmission Data of 1 Positive +
13	GND	Ground
14	RxIN2-	Transmission Data of 2 Negative -
15	RxIN2+	Transmission Data of 2 Positive +
16	GND	Ground
17	RxCLKIN-	Sampling Clock of Negative -
18	RxCLKIN+	Sampling Clock of Positive +
19	NC	No Connection
20	NC	No Connection
21	NC	No Connection
22	GND	Ground
23	NC	No Connection
24	NC	No Connection
25	GND	Ground
26	NC	No Connection
27	NC	
28	GND	Ground
29	NC	No Connection
30	NC	No Connection

 <b>京东方</b> <b>BOE</b>	<b>PRODUCT GROUP</b>	REV	ISSUE DATE
	TFT- LCD PRODUCT	P0	2011.11.23
SPEC. NUMBER	SPEC. TITLE HB156WX1-100 Preliminary Product Specification		PAGE 16 OF 36

<b>Terminal</b>	<b>Symbol</b>	<b>Functions</b>
Pin No.	Symbol	Description
31	VLED_GND	LED Ground
32	VLED_GND	LED Ground
33	VLED_GND	LED Ground
34	NC	No Connection
35	PWM	System PWM Signal Input
36	LED_EN	LED enable pin(+3.3V Input)
37	NC	No Connection
38	VLED	LED Power Supply 6V-21V
39	VLED	LED Power Supply 6V-21V
40	VLED	LED Power Supply 6V-21V

## Note.1

-BIST="H (3.3V)" : Display BIST pattern @ No LVDS CLK or DE

(white->black->red->green->blue->white...)

-BIST="L(GND or NC)" : Display black pattern @ No LVDS CLK or DE

 <b>京东方 BOE</b>	<b>PRODUCT GROUP</b>	REV	ISSUE DATE
	TFT- LCD PRODUCT	P0	2011.11.23
SPEC. NUMBER	SPEC. TITLE HB156WX1-100 Preliminary Product Specification		PAGE 17 OF 36

### 5-2. LVDS Interface

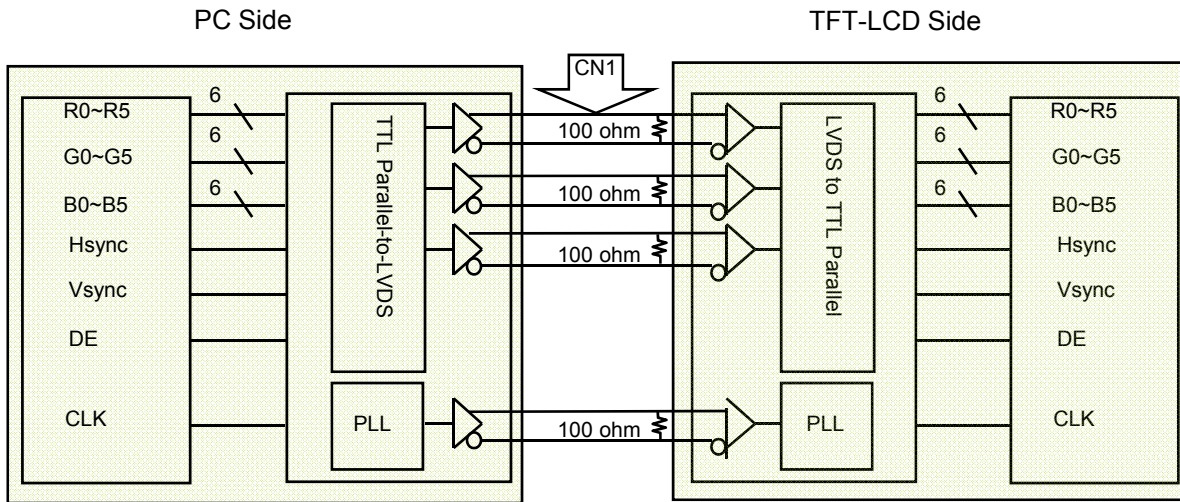

Note. Transmitter : Thine THC63LVDM63A or equivalent.  
Transmitter is not contained in Module.

### 5.3.LVDS Input signal

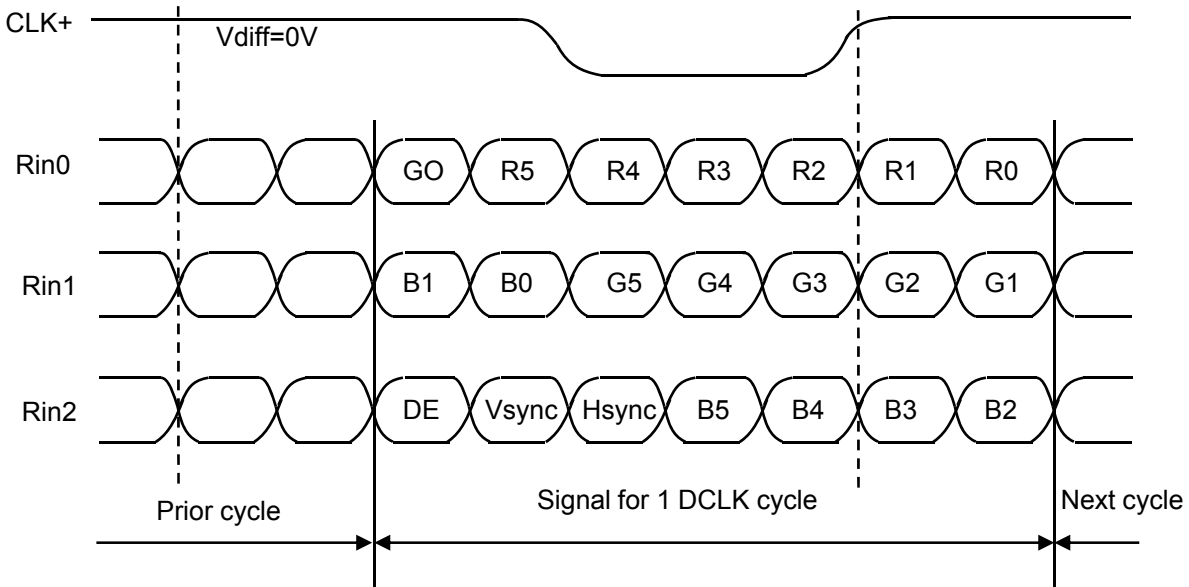

Note. Pin connection in case of using Thine THC63LVDM63A

 <b>京东方 BOE</b>	<b>PRODUCT GROUP</b>	REV	ISSUE DATE
	TFT- LCD PRODUCT	P0	2011.11.23
SPEC. NUMBER	SPEC. TITLE HB156WX1-100 Preliminary Product Specification	PAGE 18 OF 36	

### 5.3 Data Input Format

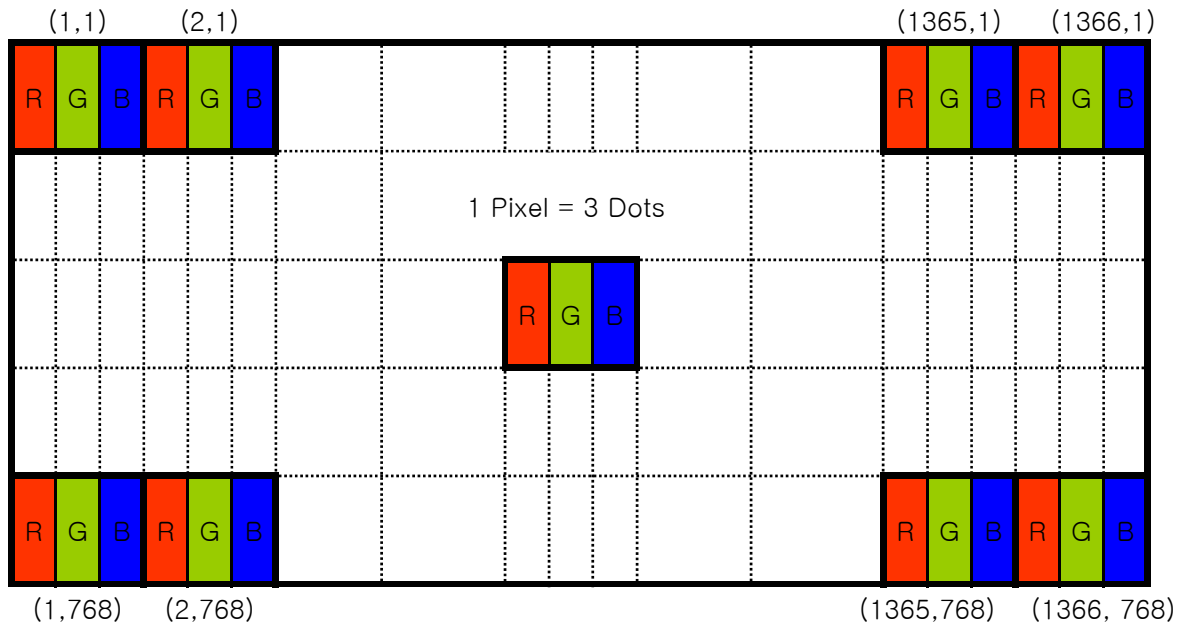

Display Position of Input Data (V-H)

### 5.4 Back-light & LCM Interface Connection

Interface Connector: CRT 098-10W10AO

<Table 7. Pin Assignments for the BLU & LCM Connector>

Pin No.	Symbol	Description	Pin No.	Symbol	Description
1	LED6	LED cathode connection	6	LED1	LED cathode connection
2	LED5	LED cathode connection	7	NC	No Connection
3	LED4	LED cathode connection	8	Vout	LED anode connection
4	LED3	LED cathode connection	9	Vout	LED anode connection
5	LED2	LED cathode connection	10	Vout	LED anode connection

 <b>京东方 BOE</b>	<b>PRODUCT GROUP</b>	REV	ISSUE DATE
	TFT- LCD PRODUCT	P0	2011.11.23
SPEC. NUMBER	SPEC. TITLE HB156WX1-100 Preliminary Product Specification		PAGE 19 OF 36

## 6.0 SIGNAL TIMING SPECIFICATION

6.1 The HB156WX1-100 is operated by the DE only.

Item		Symbols	Min	Typ	Max	Unit
Clock	Frequency	1/Tc	67.5	71.72	76.32	MHz
	High Time	Tch	-	4/7	-	Tc
	Low Time	Tcl	-	3/7	-	Tc
Frame Period		Tv	778	790	802	lines
			-	60	-	Hz
			-	16.7	-	ms
Vertical Display Period		Tvd	768	768	768	lines
One line Scanning Period		Th	1446	1526	1586	clocks
Horizontal Display Period		Thd	1366	1366	1366	clocks

	PRODUCT GROUP	REV	ISSUE DATE
	TFT- LCD PRODUCT	P0	2011.11.23
SPEC. NUMBER	SPEC. TITLE HB156WX1-100 Preliminary Product Specification		PAGE 20 OF 36

### 6.2 LVDS Rx Interface Timing Parameter

The specification of the LVDS Rx interface timing parameter is shown in Table 8.

<Table 8. LVDS Rx Interface Timing Specification>

Item	Symbol	Min	Typ	Max	Unit	Remark
CLKIN Period	tRCIP	-	13.83	14.8	nsec	
CLK Difference	tCdiff	-tRCIP*(3/7)	0	+tRCIP*(3/7)	nsec	
Input Data 0	tRIP1	-0.4	0.0	+0.4	nsec	
Input Data 1	tRIP0	tRCIP/7-0.4	tRCIP/7	tRCIP/7+0.4	nsec	
Input Data 2	tRIP6	2 × tRCIP/7-0.4	2 × tRCIP/7	2 × tRCIP/7+0.4	nsec	
Input Data 3	tRIP5	3 × tRCIP/7-0.4	3 × tRCIP/7	3 × tRCIP/7+0.4	nsec	
Input Data 4	tRIP4	4 × tRCIP/7-0.4	4 × tRCIP/7	4 × tRCIP/7+0.4	nsec	
Input Data 5	tRIP3	5 × tRCIP/7-0.4	5 × tRCIP/7	5 × tRCIP/7+0.4	nsec	
Input Data 6	tRIP2	6 × tRCIP/7-0.4	6 × tRCIP/7	6 × tRCIP/7+0.4	nsec	

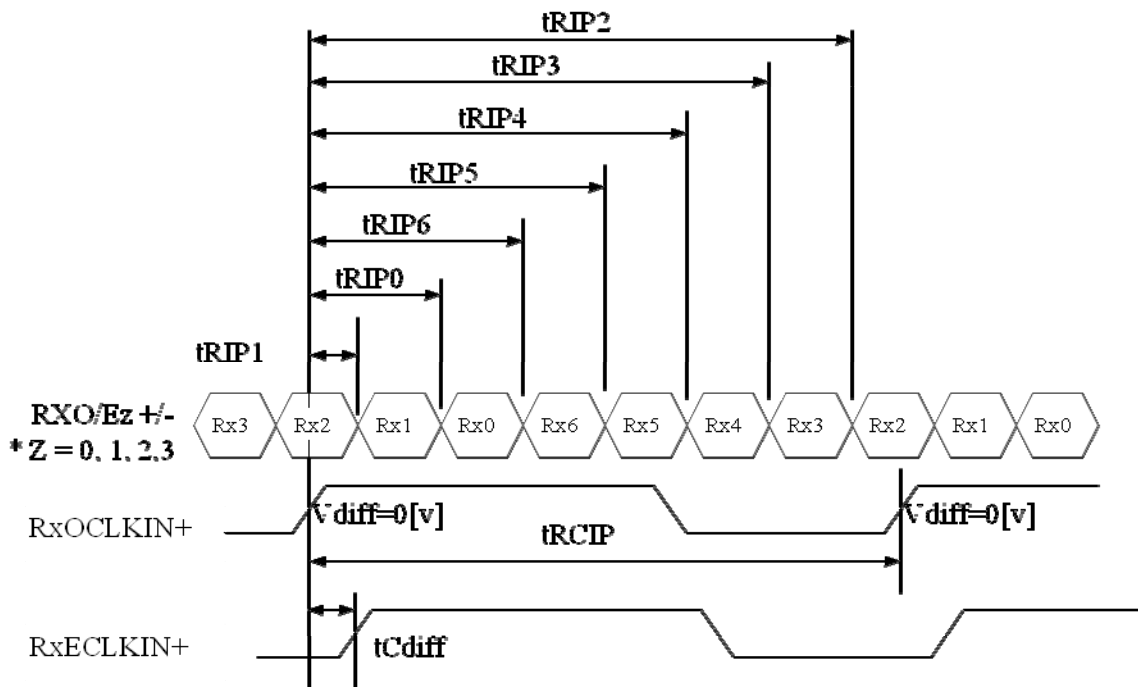

\*  $V_{diff} = (RXO/Ez+) - (RXO/Ez-), \dots, (RXO/ECLK+) - (RXO/ECLK-)$

 <b>京东方 BOE</b>	<b>PRODUCT GROUP</b>	REV	ISSUE DATE
	TFT- LCD PRODUCT	P0	2011.11.23
SPEC. NUMBER	SPEC. TITLE HB156WX1-100 Preliminary Product Specification		PAGE 21 OF 36

## 7.0 SIGNAL TIMING WAVEFORMS OF INTERFACE SIGNAL

### 7.1 Sync Timing Waveforms

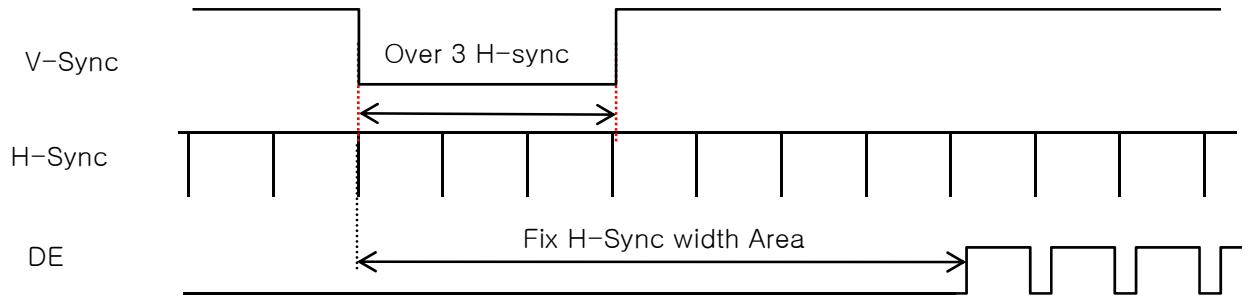

- 1) Need over 3 H-sync during V-Sync Low
- 2) Fix H-Sync width from V-Sync falling edge to first rising edge

### 7.2 Vertical Timing Waveforms

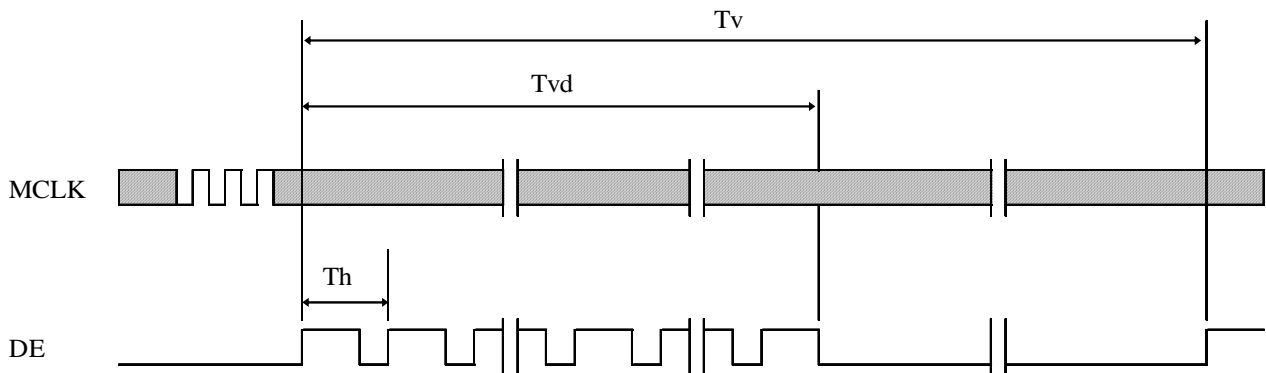

 <b>京东方</b> <b>BOE</b>	<b>PRODUCT GROUP</b>	REV	ISSUE DATE
	TFT- LCD PRODUCT	P0	2011.11.23
SPEC. NUMBER	SPEC. TITLE HB156WX1-100 Preliminary Product Specification		PAGE 22 OF 36

### 7.3 Horizontal Timing Waveforms

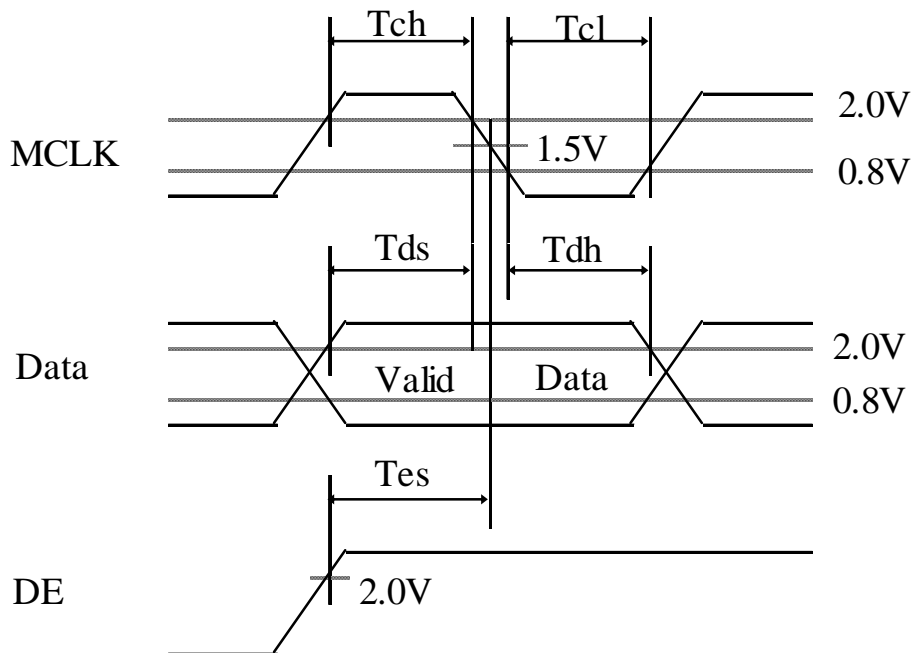
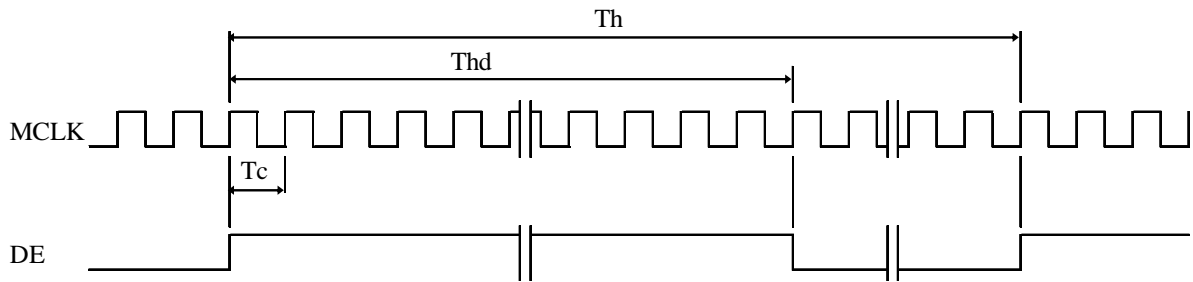

 <b>京东方 BOE</b>	<b>PRODUCT GROUP</b>	REV	ISSUE DATE
	TFT- LCD PRODUCT	P0	2011.11.23
SPEC. NUMBER	SPEC. TITLE HB156WX1-100 Preliminary Product Specification		PAGE 23 OF 36

### 8.0 INPUT SIGNALS, BASIC DISPLAY COLORS & GRAY SCALE OF COLORS

	Colors & Gray scale	Data signal																	
		R0	R1	R2	R3	R4	R5	G0	G1	G2	G3	G4	G5	B0	B1	B2	B3	B4	B5
Basic colors	Black	0	0	0	0	0	0	0	0	0	0	0	0	0	0	0	0	0	0
	Blue	0	0	0	0	0	0	0	0	0	0	0	0	1	1	1	1	1	1
	Green	0	0	0	0	0	0	1	1	1	1	1	1	0	0	0	0	0	0
	Light Blue	0	0	0	0	0	0	1	1	1	1	1	1	1	1	1	1	1	1
	Red	1	1	1	1	1	1	0	0	0	0	0	0	0	0	0	0	0	0
	Purple	1	1	1	1	1	1	0	0	0	0	0	0	1	1	1	1	1	1
	Yellow	1	1	1	1	1	1	1	1	1	1	1	1	0	0	0	0	0	0
	White	1	1	1	1	1	1	1	1	1	1	1	1	1	1	1	1	1	1
Gray scale of Red	Black	0	0	0	0	0	0	0	0	0	0	0	0	0	0	0	0	0	0
	△ Darker	1	0	0	0	0	0	0	0	0	0	0	0	0	0	0	0	0	0
	△ ▽				↑						↓						↑		
	Brighter ▽	1	0	1	1	1	1	0	0	0	0	0	0	0	0	0	0	0	0
	▽	0	1	1	1	1	1	0	0	0	0	0	0	0	0	0	0	0	0
	Red	1	1	1	1	1	1	0	0	0	0	0	0	0	0	0	0	0	0
Gray scale of Green	Black	0	0	0	0	0	0	0	0	0	0	0	0	0	0	0	0	0	0
	△ Darker	0	0	0	0	0	0	1	0	0	0	0	0	0	0	0	0	0	0
	△ ▽				↑						↓						↑		
	Brighter ▽	0	0	0	0	0	0	1	0	1	1	1	1	0	0	0	0	0	0
	▽	0	0	0	0	0	0	0	1	1	1	1	1	0	0	0	0	0	0
	Green	0	0	0	0	0	0	1	1	1	1	1	1	0	0	0	0	0	0
Gray scale of Blue	Black	0	0	0	0	0	0	0	0	0	0	0	0	0	0	0	0	0	0
	△ Darker	0	0	0	0	0	0	0	0	0	0	0	0	1	0	0	0	0	0
	△ ▽				↑						↓						↑		
	Brighter ▽	0	0	0	0	0	0	0	0	0	0	0	0	1	0	1	1	1	1
	▽	0	0	0	0	0	0	0	0	0	0	0	0	0	1	1	1	1	1
	Blue	0	0	0	0	0	0	0	0	0	0	0	0	1	1	1	1	1	1
Gray scale of White & Black	Black	0	0	0	0	0	0	0	0	0	0	0	0	0	0	0	0	0	0
	△ Darker	1	0	0	0	0	0	1	0	0	0	0	0	1	0	0	0	0	0
	△ ▽				↑						↓						↑		
	Brighter ▽	1	0	1	1	1	1	1	0	1	1	1	1	1	0	1	1	1	1
	▽	0	1	1	1	1	1	0	1	1	1	1	1	0	1	1	1	1	1
	White	1	1	1	1	1	1	1	1	1	1	1	1	1	1	1	1	1	1

 <b>京东方 BOE</b>	<b>PRODUCT GROUP</b>	REV	ISSUE DATE
	TFT- LCD PRODUCT	P0	2011.11.23
SPEC. NUMBER	SPEC. TITLE HB156WX1-100 Preliminary Product Specification		PAGE 24 OF 36

### 9.0 POWER SEQUENCE

To prevent a latch-up or DC operation of the LCD module, the power on/off sequence shall be as shown in below

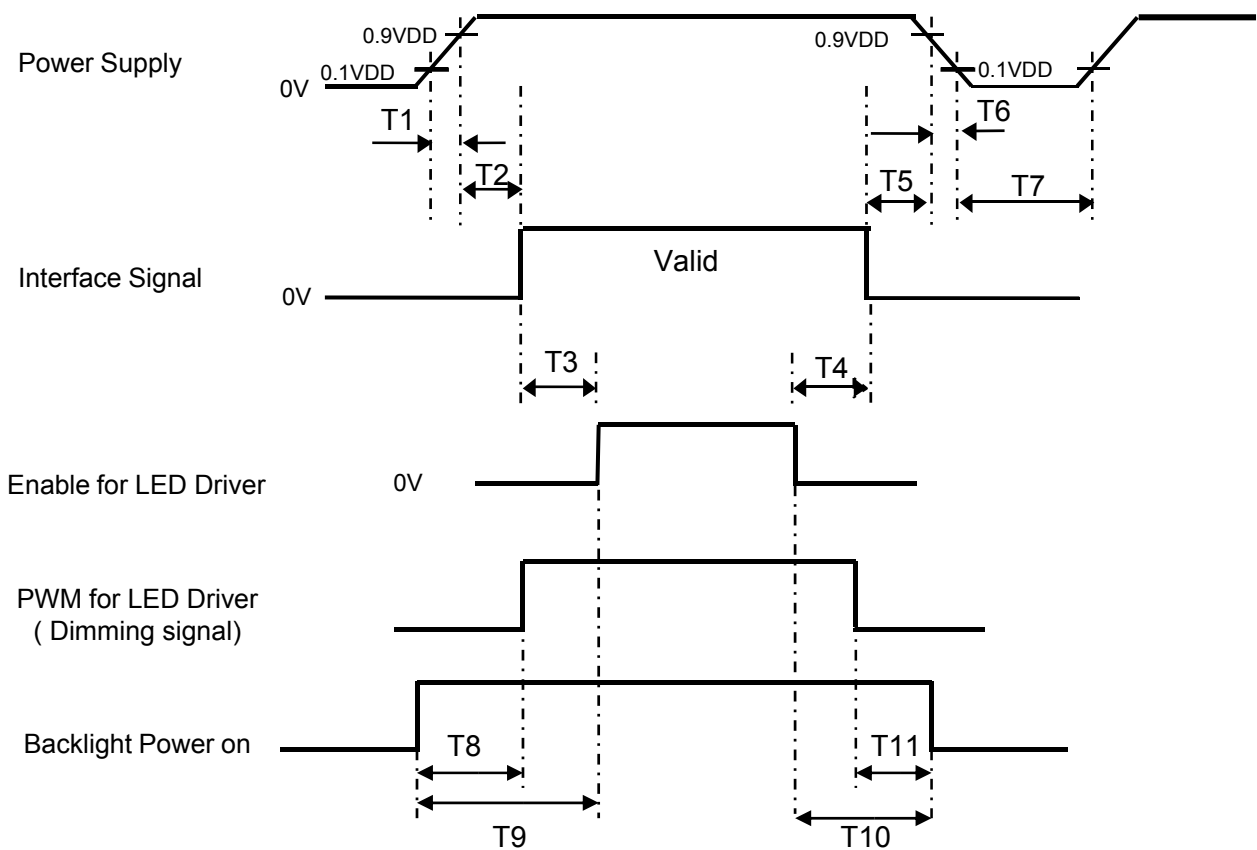

- 0.5ms ≤ T1 ≤ 10 ms
- 0 ms ≤ T2 ≤ 50 ms
- 200 ms ≤ T3
- 0 ms ≤ T4
- 0 ms ≤ T5
- 0 ms ≤ T6 ≤ 10ms
- 150ms ≤ T7
- 0ms ≤ T8
- 0 ms ≤ T9
- 0ms ≤ T10
- 0ms ≤ T11

**Notes:**

1. When the power supply VDD is 0V, keep the level of input signals on the low or keep high impedance.
2. Do not keep the interface signal high impedance when power is on. Back Light must be turn on after power for logic and interface signal are valid.

 <b>京东方</b> <b>BOE</b>	<b>PRODUCT GROUP</b>	REV	ISSUE DATE
	TFT- LCD PRODUCT	P0	2011.11.23
SPEC. NUMBER	SPEC. TITLE HB156WX1-100 Preliminary Product Specification		PAGE 25 OF 36

## 10.0 Connector Description

Physical interface is described as for the connector on LCM.

These connectors are capable of accommodating the following signals and will be following components.

### 10.1 TFT LCD Module

Connector Name /Description	For Signal Connector
Manufacturer	STM
Type/ Part Number	MSAK24025P40G or Compatible
Mating housing/ Part Number	I-PEX 20455-040T-11 or Compatible

 <b>京东方</b> <b>BOE</b>	<b>PRODUCT GROUP</b>	REV	ISSUE DATE
	TFT- LCD PRODUCT	P0	2011.11.23
SPEC. NUMBER	SPEC. TITLE HB156WX1-100 Preliminary Product Specification	PAGE 26 OF 36	

## 11.0 MECHANICAL CHARACTERISTICS

### 11.1 Dimensional Requirements

FIGURE 6 shows mechanical outlines for the model HB156WX1-100.  
Other parameters are shown in Table 9.

<Table 9. Dimensional Parameters>

Parameter	Specification	Unit
Active Area	344.232 (H) × 193.536 (V)	
Number of pixels	1366 (H) X 768 (V) (1 pixel = R + G + B dots)	
Pixel pitch	0.252 (H) X 0.252 (V)	
Pixel arrangement	RGB Vertical stripe	
Display colors	262,144	
Display mode	Normally white	
Dimensional outline	$359.3 \pm 0.5 \times 209.5 \pm 0.5 \times 5.5(\text{max})$	mm
Weight	450 (max)	gram
Back Light	Connector : CRT 098-10W010A0	
	LED, Horizontal LED Array type	

### 11.2 Mounting

See FIGURE 6.

### 11.3 Glare and Polarizer Hardness.

The surface of the LCD has a glare coating to maximize readability and hard coating to reduce scratching.

### 11.4 Light Leakage

There shall not be visible light from the back-lighting system around the edges of the screen as seen from a distance 50cm from the screen with an overhead light level of 350lux.

 <b>京东方</b> <b>BOE</b>	<b>PRODUCT GROUP</b>	REV	ISSUE DATE
	TFT- LCD PRODUCT	P0	2011.11.23
SPEC. NUMBER	SPEC. TITLE HB156WX1-100 Preliminary Product Specification	PAGE 27 OF 36	

## 12.0 RELIABILITY TEST

The Reliability test items and its conditions are shown in below.

<Table 10. Reliability test>

No	Test Items	Conditions
1	High temperature storage test	Ta = 60 °C, 240 hrs
2	Low temperature storage test	Ta = -20 °C, 240 hrs
3	High temperature & high humidity operation test	Ta = 50 °C, 50%RH, 240 hrs
4	High temperature operation test	Ta = 50 °C, 240 hrs
5	Low temperature operation test	Ta = 0 °C, 240 hrs
6	Thermal shock	Ta = -20 °C ↔ 60 °C (0.5 hr), 100 cycle
7	Vibration test (non-operating)	1.5G, 1~500Hz sine +X,+Y+Z Sweep rate : 30min.
8	Shock test (non-operating)	220G, Half Sine Wave 2msec ± X, ± Y, ± Z Once for each direction
9	Electro-static discharge test (non-operating)	Air : 150 pF, 330Ω, 15 KV Contact : 150 pF, 330Ω, 8 KV

## 13.0 HANDLING & CAUTIONS

### (1) Cautions when taking out the module

- Pick the pouch only, when taking out module from a shipping package.

### (2) Cautions for handling the module

- As the electrostatic discharges may break the LCD module, handle the LCD module with care. Peel a protection sheet off from the LCD panel surface as slowly as possible.
- As the LCD panel and back - light element are made from fragile glass material, impulse and pressure to the LCD module should be avoided.
- As the surface of the polarizer is very soft and easily scratched, use a soft dry cloth without chemicals for cleaning.
- Do not pull the interface connector in or out while the LCD module is operating.
- Put the module display side down on a flat horizontal plane.
- Handle connectors and cables with care.

### (3) Cautions for the operation

- When the module is operating, do not lose CLK, ENAB signals. If any one of these signals is lost, the LCD panel would be damaged.
- Obey the supply voltage sequence. If wrong sequence is applied, the module would be damaged.

	<b>PRODUCT GROUP</b>	REV	ISSUE DATE
	TFT- LCD PRODUCT	P0	2011.11.23
SPEC. NUMBER	SPEC. TITLE HB156WX1-100 Preliminary Product Specification		PAGE 28 OF 36

- (4) Cautions for the atmosphere
- Dew drop atmosphere should be avoided.
  - Do not store and/or operate the LCD module in a high temperature and/or humidity atmosphere. Storage in an electro-conductive polymer packing pouch and under relatively low temperature atmosphere is recommended.
- (5) Cautions for the module characteristics
- Do not apply fixed pattern data signal to the LCD module at product aging.
  - Applying fixed pattern for a long time may cause image sticking.
- (6) Other cautions
- Do not disassemble and/or re-assemble LCD module.
  - Do not re-adjust variable resistor or switch etc.
  - When returning the module for repair or etc., Please pack the module not to be broken. We recommend to use the original shipping packages.

### 14.0 LABEL

(1) Product label

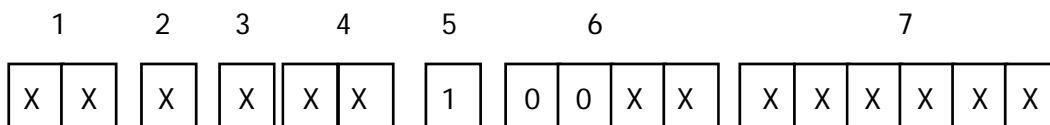

Type designation	No 5. Month (1, 2, 3, ..., 9, X, Y, Z)
No 1. Control Number	No 6. Product Identification (FG)
No 2. Rank / Grade	No 7. Serial Number
No 3. Line classification (BOE HF:3)	
No 4. Year (05 : 2005, 06: 2006, ...)	

 <b>京东方 BOE</b>	<b>PRODUCT GROUP</b>	REV	ISSUE DATE
	TFT- LCD PRODUCT	P0	2011.11.23
SPEC. NUMBER	SPEC. TITLE HB156WX1-100 Preliminary Product Specification		PAGE 29 OF 36

(2) Box label

Label Size: 110 mm (L) × 56 mm (W)

Contents

Model: HB156WX1-100

Q`ty: Module Q`ty in one box

Serial No.: Box Serial No. See next figure for detail description.

Date: Packing Date

Internal use of Product

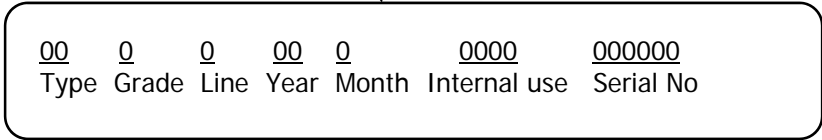
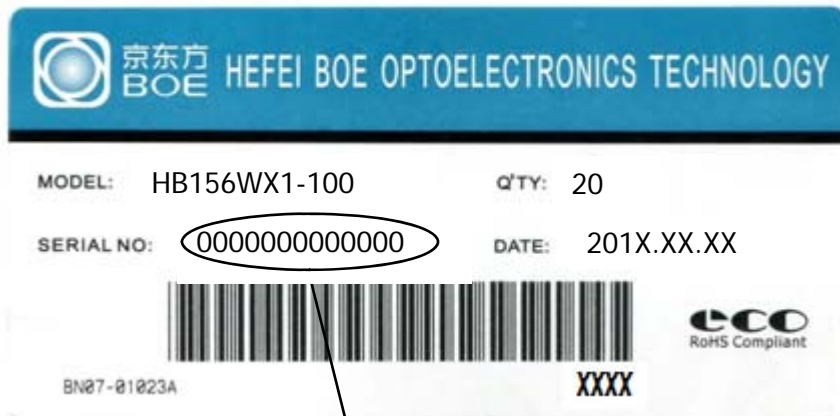

 <b>京东方 BOE</b>	<b>PRODUCT GROUP</b>	REV	ISSUE DATE
	TFT- LCD PRODUCT	P0	2011.11.23
SPEC. NUMBER	SPEC. TITLE HB156WX1-100 Preliminary Product Specification		PAGE 30 OF 36

## 15.0 PACKING INFORMATION

### 15.1 Packing order

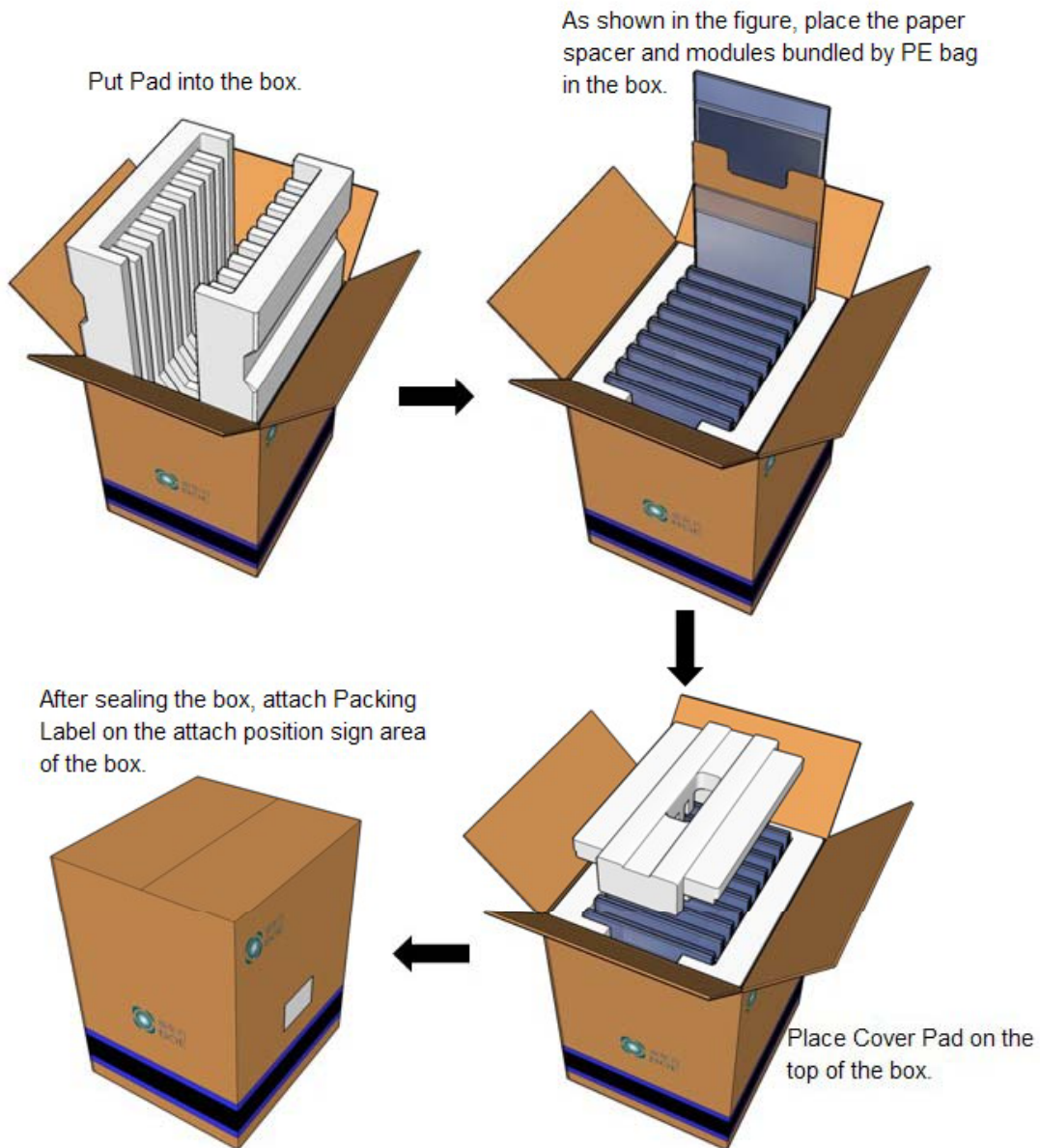

### 15.2 Notes

- Box Dimension: 364mm(W) x 332mm(D) x 453mm(H)
- Package Quantity in one Box: 20pcs
- Total Weight: 11kg

	<b>PRODUCT GROUP</b>	REV	ISSUE DATE
	TFT- LCD PRODUCT	P0	2011.11.23
SPEC. NUMBER	SPEC. TITLE HB156WX1-100 Preliminary Product Specification		PAGE 31 OF 36

## 16.0 MECHANICAL OUTLINE DIMENSION

Figure 6. TFT-LCD Module Outline Dimension (Front View)

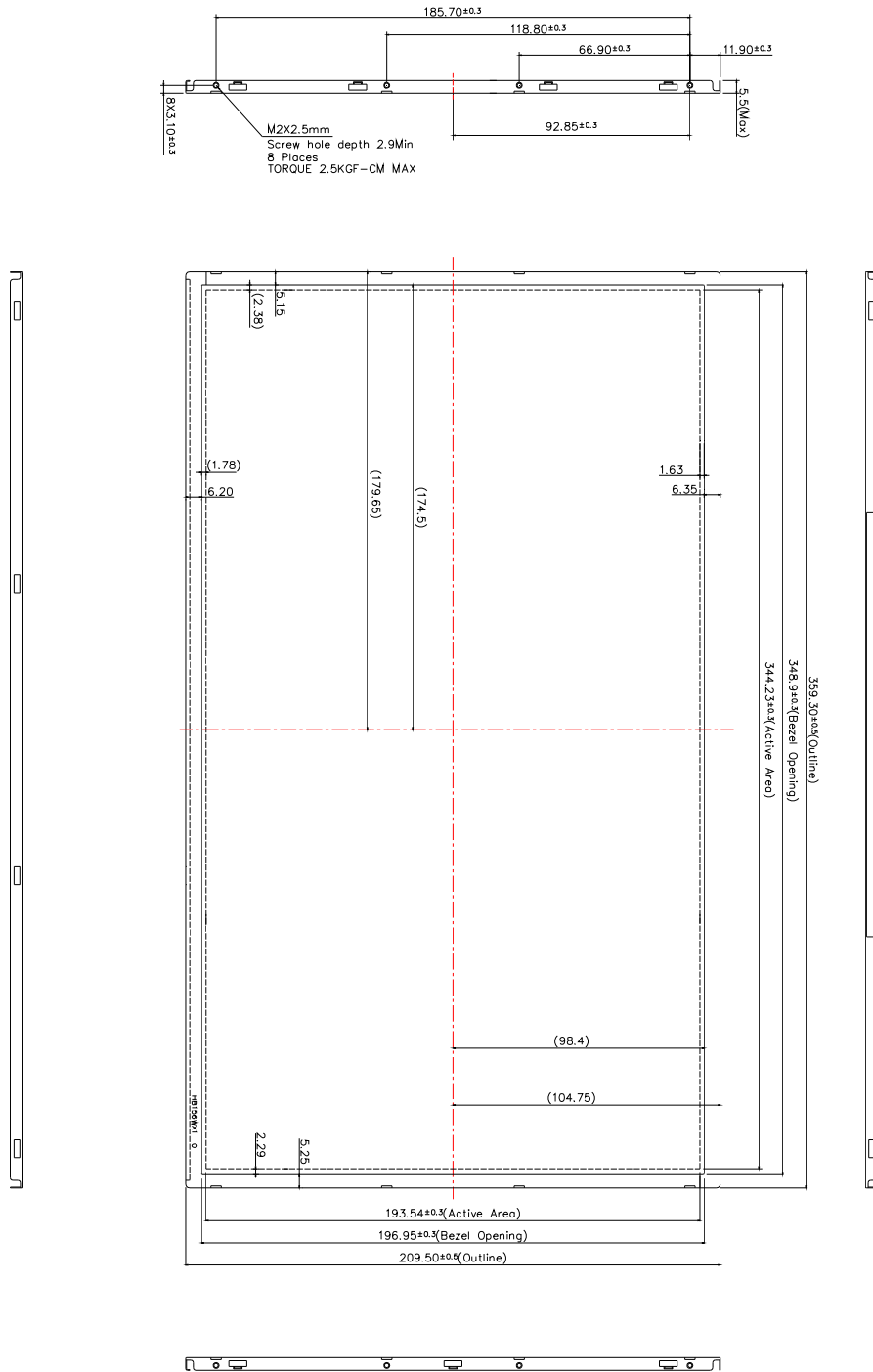



	PRODUCT GROUP	REV	ISSUE DATE
	TFT- LCD PRODUCT	P0	2011.11.23
SPEC. NUMBER	SPEC. TITLE	PAGE	
	HB156WX1-100 Preliminary Product Specification	32 OF 36	

Figure 7. TFT-LCD Module Outline Dimensions (Rear view)

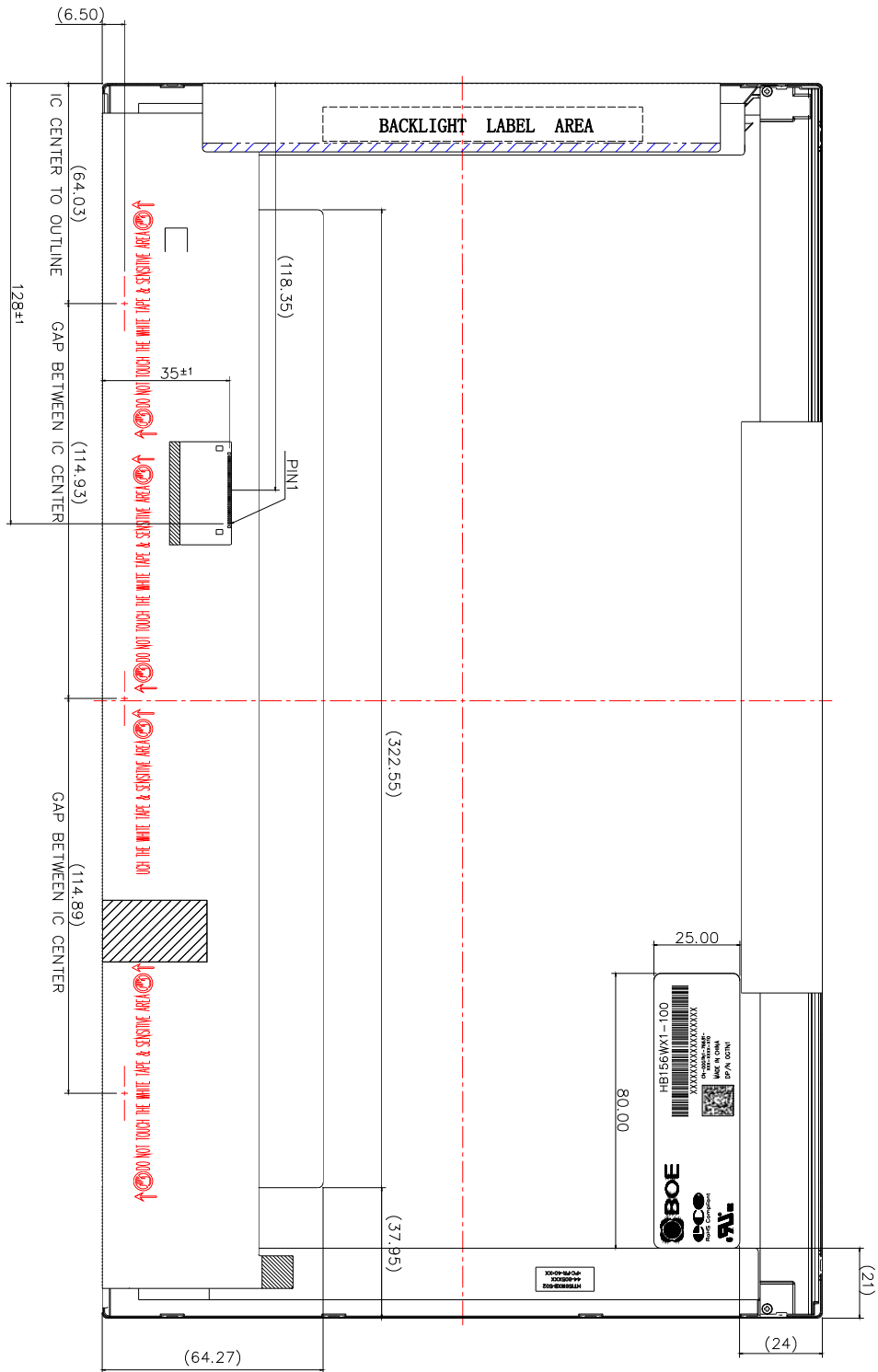

NOTE:  
 1.LCD MODULE INPUT CONNECTOR:STM MSAK24025P40G &  
 187088-40041 (P-TWO)  
 2.PREVENTION IC DAMAGE.IC POSITION NOT ALLOWED ANY  
 OVERLAP OVER THOSE AREAS

 <b>京东方 BOE</b>	<b>PRODUCT GROUP</b>	REV	ISSUE DATE
	TFT- LCD PRODUCT	P0	2011.11.23
SPEC. NUMBER	SPEC. TITLE HB156WX1-100 Preliminary Product Specification		PAGE 33 OF 36

## 17.0 EDID Table

Address (HEX)	Function	Hex	Dec	crc	Input values.	Notes
00	Header	00	0		0	EDID Header
01		FF	255		255	
02		FF	255		255	
03		FF	255		255	
04		FF	255		255	
05		FF	255		255	
06		FF	255		255	
07		00	0		0	
08	ID Manufacturer Name	09	9		BOE	ID = BOE
09		E5	229			
0A	ID Product Code	B3	179		1459	ID = 1459
0B		05	5			
0C	32-bit serial No.	00	0			
0D		00	0			
0E		00	0			
0F		00	0			
10	Week of manufacture	1	1		1	
11	Year of Manufacture	16	22		2012	Manufactured in 2012
12	EDID Structure Ver.	01	1		1	EDID Ver 1.0
13	EDID revision #	04	4		4	EDID Rev. 0.4
14	Video input definition	90	144		-	
15	Max H image size	22	34		34	34 cm (Approx)
16	Max V image size	13	19		19	19 cm (Approx)
17	Display Gamma	78	120		2.2	Gamma curve = 2.2
18	Feature support	0A	10			RGB display, Preferred Timming mode
19	Red/Green low bits	F8	248		-	Red / Green Low Bits
1A	Blue/White low bits	90	144		-	Blue / White Low Bits
1B	Red x high bits	9E	158	631	0.617	Red (x) = 10011110 (0.617)
1C	Red y high bits	59	89	359	0.351	Red (y) = 01011001 (0.351)
1D	Green x high bits	55	85	342	0.334	Green (x) = 01010101 (0.334)
1E	Green y high bits	9C	156	624	0.610	Green (y) = 10011100 (0.61)
1F	Blue x high bits	26	38	154	0.151	Blue (x) = 00100110 (0.151)
20	Blue y high bits	1A	26	105	0.103	Blue (y) = 00011010 (0.103)
21	White x high bits	50	80	320	0.313	White (x) = 01010000 (0.313)
22	White y high bits	54	84	336	0.329	White (y) = 01010100 (0.329)

 <b>京东方 BOE</b>	<b>PRODUCT GROUP</b>	REV	ISSUE DATE
	TFT- LCD PRODUCT	P0	2011.11.23
SPEC. NUMBER	SPEC. TITLE HB156WX1-100 Preliminary Product Specification		PAGE 34 OF 36

Address (HEX)	Function	Hex	Dec	crc	Input values.	Notes
23	Established timing 1	00	0		-	
24	Established timing 2	00	0		-	
25	Established timing 3	00	0		-	
26	Standard timing #1	01	1			Not Used
27		01	1			
28	Standard timing #2	01	1			Not Used
29		01	1			
2A	Standard timing #3	01	1			Not Used
2B		01	1			
2C	Standard timing #4	01	1			Not Used
2D		01	1			
2E	Standard timing #5	01	1			Not Used
2F		01	1			
30	Standard timing #6	01	1			Not Used
31		01	1			
32	Standard timing #7	01	1			Not Used
33		01	1			
34	Standard timing #8	01	1			Not Used
35		01	1			
36	Detailed timing/monitor descriptor #1	04	4		71.72	71.72MHz Main clock
37		1C	28			
38		56	86		1366	Hor Active = 1366
39		93	147		147	Hor Blanking = 147
3A		50	80		-	4 bits of Hor. Active + 4 bits of Hor. Blanking
3B		00	0		768	Ver Active = 768
3C		16	22		22	Ver Blanking = 22
3D		30	48		-	4 bits of Ver. Active + 4 bits of Ver. Blanking
3E		30	48		48	Hor Sync Offset = 48
3F		20	32		32	H Sync Pulse Width = 32
40		36	54		3	V sync Offset = 3 line
41		00	0		6	V Sync Pulse width : 6 line
42		58	88		344	Horizontal Image Size = 344 mm (Low 8 bits)
43		C1	193		193	Vertical Image Size = 193 mm (Low 8 bits)
44		10	16		-	4 bits of Hor Image Size + 4 bits of Ver Image Size
45		00	0		0	Hor Border (pixels)
46		00	0		0	Vertical Border (Lines)
47	1A	26			Refer to right table	

 <b>京东方 BOE</b>	<b>PRODUCT GROUP</b>	REV	ISSUE DATE
	TFT- LCD PRODUCT	P0	2011.11.23
SPEC. NUMBER	SPEC. TITLE HB156WX1-100 Preliminary Product Specification		PAGE 35 OF 36

Address (HEX)	Function	Hex	Dec	crc	Input values.	Notes
48	Detailed timing/monitor descriptor #2	D6	214		48.22	48.22MHz Main clock
49		12	18			
4A		56	86		1366	Hor Active = 1366
4B		A0	160		160	Hor Blanking = 160
4C		50	80		-	4 bits of Hor. Active + 4 bits of Hor. Blanking
4D		00	0		768	Ver Active = 768
4E		16	22		22	Ver Blanking = 22
4F		30	48		-	4 bits of Ver. Active + 4 bits of Ver. Blanking
50		30	48		48	Hor Sync Offset = 48
51		20	32		32	H Sync Pulse Width = 32
52		36	54		3	V sync Offset = 3 line
53		00	0		6	V Sync Pulse width : 6 line
54		58	88		344	Horizontal Image Size = 344 mm (Low 8 bits)
55		C1	193		193	Vertical Image Size = 193 mm (Low 8 bits)
56		10	16		-	4 bits of Hor Image Size + 4 bits of Ver Image Size
57		00	0		0	Hor Border (pixels)
58		00	0		0	Vertical Border (Lines)
59	1A	26				
5A	Detailed timing/monitor descriptor #3	00	0			ASCII Data Sting Tag
5B		00	0			
5C		00	0			
5D		FE	254			
5E		00	0			
5F		30	48		0	D/PN: 0GTN1
60		47	71		G	
61		54	84		T	
62		4E	78		N	
63		31	49		1	EDID:X10
64		0A	10		1010	
65		48	72		H	BOE PN
66		42	66		B	
67		31	49		1	
68	35	53		5		
69	31	49		1		
6A	30	48		0		
6B	30	48		0		

 <b>京东方 BOE</b>	<b>PRODUCT GROUP</b>	REV	ISSUE DATE
	TFT- LCD PRODUCT	P0	2011.11.23
SPEC. NUMBER	SPEC. TITLE HB156WX1-100 Preliminary Product Specification		PAGE 36 OF 36

Address (HEX)	Function	Hex	Dec	crc	Input values.	Notes
6C	Detailed timing/monitor descriptor #4	00	0			Product Name Tag (ASCII)
6D		00	0			
6E		00	0			
6F		00	0			
70		00	0			
71		00	0		00000000	6-bit Color Depth & no FRC
72		41	65		01000001	WLED & singal light bar & one light bar
73		01	1		00000001	Frame rate 40Hz~65Hz
74		94	148		10010110	Light Controller:PWM & Max. Luminance 220
75		01	1		00000001	Front Surface:Glossy & RGB v-stripe
76		00	0		00000000	no NTSC & no DBC
77		00	0		00000000	no Motion Blur & no Active Gamma
78		00	0		00000000	no Wireless Enhancement & no In-Cell Scanner
79		01	1		00000001	Single LVDS
7A		01	1		00000001	Built-In Self Test
7B		0A	10			
7C	20	32				
7D	20	32				
7E	Extension flag	00	0			
7F	Checksum	FE	FE	254	-	